

Cotton
Swap
Forceps



About Us

History

Serving more than 100 years in the field of Surgical, Dental, Manicure & Pedicure Implements, Veterinary and Jewelry Tools etc. Our grandfather was the pioneer who laid down the founding tone of the manufacturing of surgical instruments since 1908. This is our family business and we are the 3rd generation in this field.

Introduction

Coltene Dental Supplier was established in 2014 the company has, since the start, developed a stable and steady growth. The company success though, is due to the support of health authorities which have recognized our compromised to quality and punctuality.

Our Philosophy

Our philosophy is to share our knowledge and experience with our customers and give them all the professional assistance they might need.

Company Policy

Coltene Dental Supplier shall not compromise on quality of the products. We shall achieve quality excellence by using quality assurance programs and techniques. Prompt and dedicated services shall be ensured to customers and efficiently to the best of our ability.

Our Commitment

Our commitment to quality, based on our continuous monitoring at every stage of the manufacturing process has placed us at par with international standards, while maintaining very competitive prices.

Quality Management System

Coltene Dental Supplier manufacturing process emphasizes quality above all else. Our employees are having a ten to fifteen-years technical and practical experience in order to achieve, international standards. The proper stainless steel, stamping and forged materials used are meticulously selected and go through highly effective quality control. All surgical instruments are manufactured using the highest quality Pakistani, German, French and Japanese medical grade Stainless Steel. Every Instrument is Hand Examined from steel forging to final packing; no product passes to the next step unless Hand-Examined by a highly qualified and experienced technician.

100% Satisfaction Guaranteed

All our Instruments are produced with high quality stainless steel and are thoroughly checked and inspected during all phases of production, In order to ensure that they correspond to the international standards laid down by the **ISO 13485:2016, ISO 7153-1:2016 EN 10088-1:2005, ISO 9001:2015 and CE** standards and are confirmation of their compliance to use.

Product Materials

We are Manufacturing stainless steel Grades **AISI 410, 420, 304, 302 ASTM F899** steel according international standards.

Also French & German & Japanese's steel technology that removes calculus efficiently, while retaining its sharp Coltene Dental Supplier for a longer period of time.

About Us

Coltene Dental Supplier Instruments hold the highest quality standards throughout the creation of the instrument from raw materials to finished product.

We believe in our products and provide the user with a 100% customer satisfaction guarantee. Please feel free to contact us for any information.

Our Staff

We are convinced that a highly qualified staff brings trust in our company. We are tight team, consisting of people, who with their education and experience contribute to our company strength.

Support

Our friendly and well-trained staff will happy to assist you. If you are looking for something that not in our range of products, So we will do our best to help you.

Terms & Condition

Processing of Ordered Goods: after finalize the contract, we start production the articles with zest and zeal, to ensure prompt delivery.

Minimum Order

The minimum order is Euro €.1000.00, US\$.1000.00

Price

We normally quote FOB prices. However, we can add freight, shipping and postage charges depending upon the requirement of the buyer.

Payment

We accept L/C, D/P, T/T, Western Union, Money Gram payments for conformed orders. We prefer 70% advance and the remain 30% on completion of the goods but before shipment. The goods will remain the property of Coltene Dental Supplier before total payment of the order.

We accept Irrevocable Letter of Credit (L/C).

Mode of Shipment

It depends on the requirement of buyer.

Claim

We always supply the goods with utmost care in all aspects; but still out of human error, any claim arises for any loss or damage, it must be filed within 4 days of the date of goods receipt. The claim is not negotiable after Twenty-One Days from the date of invoice.

Returns

Returns are not acceptable without prior mutual consent. Any instruments that are custom made, modified, private labeled, custom etched or otherwise modified or hampered are not returnable for

About Us

credit.

We reserve the right to inspect any returns prior to issuing any credit. Returned goods will be subject to 20% Re-stocking charges.

Repairs & Warranty Replacements

In case of any manufacturing defect, we guarantee to replace, repair any such piece(s), free of cost but this does not apply to instruments that are repaired, or hampered/mishandled at the importer's end. Instruments which have been repaired by a source other than.

Void of this warranty

Merchandise will be repaired or replaced at our discretion.

The instruments lost/damaged during this transit to us will not be our responsibility.

The freight of such articles will be borne by the consignee.

Written By: Production Manager

Signature: _____

Reviewed By: Quality Assurance Manager

Signature: _____

Approved By: CEO

Signature: _____

Dated: 01st January 2021 to 31st December 2021

User Manual

Coltene Dental Supplier is Manufacturer and Exporter of all kinds of Surgical Instruments for ENT Diagnostic, Ophthalmology & Dermatology Pocket Instruments, Premium ENT Diagnostic and Ophthalmic Instruments, Laryngoscopes, Fibre Optic Laryngoscopes, Laryngoscopes with Direct Illumination, Disposable Laryngoscopes, Laryngoscope Sets, Gynecology Sets,

INSTRUCTION MANUAL – PLEASE READ BEFORE USE SURGICAL INSTRUMENTS

The Coltene Dental Supplier culture is one of responsibility and accountability, which means we take ownership of our projects with a clear view of the final objective. We are providing the responsiveness to customer needs of a small business, but with the added innovation, advanced manufacturing methods and qualified distribution network of a truly global company. This, in essence, created what Coltene Dental Supplier stands for today: world-class products and services for our customers.

INNOVATION

At Coltene Dental Supplier we foster innovation by combining decades of experience in developing and manufacturing diagnostic devices with out-of-the-box, innovative thinking. Our people are always eager to explore new technologies. As a result we are now in the great position of being able to launch innovative products every year, while still having a well-filled product pipeline for the future.

CUSTOMER SATISFACTION

Coltene Dental Supplier 's customers expect nothing less than world-class products and services. Consequently, they are the center of all our efforts and activities, right across the company, from research and development through to manufacturing, marketing and sales. Designed for demanding, everyday use in doctors' practices and hospitals, many of our products are developed through close cooperation between our engineers and specialists from research centers and university hospitals.

During the development phase, our test procedures and facilities lay the foundation for products of outstanding quality, even before the actual manufacturing process starts.

EMPOWERMENT

Our employees are key to our success and we continue to invest in their development. From their initial training when they join Coltene Dental Supplier, followed by ongoing development programs and corporate management training, our employees are encouraged to contribute through excellence and teamwork. Our objective is to empower people and help them assume responsibility to help us, as a team, achieve our ambitious company goals.

PRODUCT LAUNCHES

Coltene Dental Supplier Product Launches Surgical Instruments for ENT, Ophthalmology & Dermatology Pocket Instruments - Premium ENT Diagnostic and Ophthalmic Instruments, Laryngoscopes, Fibre Optic (F.O.) Laryngoscopes, Laryngoscopes with Direct Illumination, Disposable Laryngoscopes, Laryngoscope Sets, Gynecology Sets, INTENDED USE These instructions for use are valid for Surgical instruments made of stainless steel, such as Extracting Forceps, instruments for Bone Surgery, Scalpels, Knives, Scissors, Forceps, Clamps, Retractors, Probes, Scalars Spatulas, Suture Root Elevators instruments with special instructions.

User Manual

Coltene Dental Supplier sets higher standards than required by norms and guidelines. In order to comply with these exceptionally high internal standards, we only use high-grade materials from reliable suppliers and apply the latest manufacturing methods, with every product having to pass several intermediate and final quality checks. All our manufacturing personnel receive expert training to ensure world-class finishing and quality. Our products come with a minimum two year warranty.

TESTS

All instruments are high-quality products whose proper handling and use will be described in the following. In order to minimize hazards for patients and users these directions must be closely obeyed. Application, maintenance and test of the instruments may only be carried out by specially skilled staff.

HANDLING

The instruments must not be over stressed by twisting or levering as this may lead to damages or cracking of the instruments.

PURPOSE / FIELD OF APPLICATION

These operating instructions are valid for standard surgical instruments of the production of Coltene Dental Supplier. The user decides according to his specialized knowledge whether the instrument may suitable for the intended purpose.

DISPOSAL

Instruments that cannot be repaired or reprocessed should be disposed in accordance with the respective disposal guidelines of the hospital.

MATERIALS

Product Materials

We are using Materials as per international standards. We have expertise to remove calculus efficiently from the Materials while retaining its sharpness which is durable for a longer period of time. Coltene Dental Supplier Instruments hold the highest quality standards throughout the creation of the instrument from raw materials to finished product.

We believe in our products and provide our clients 100% satisfaction guarantee. Please feel free to contact us for any information.

QUALITY

100% Satisfaction Guaranteed All our Instruments are produced with high quality stainless steel and are thoroughly checked and inspected during all phases of production, In order to ensure that they correspond to the international standards laid down by the **ISO 13485, ISO 9001, ISO7153-1 EN10088-1 and CE standards** and are confirmation of their compliance to use.

REPROCESSING DIRECTIONS

Instruments may in general only be processed by specially skilled staff possessing the specific knowledge for this kind of work. Detailed information to the maintenance of instruments are available in the

User Manual

“in this Brochure” of the www.coltenedental.com links to laws, norms and specialized maintenance committees can be found.

ADVICE

Instruments made of stainless steel must not be put in physiological saline solutions (NaCl), as longer contact may lead to corrosion damages. Instruments may only be sterilized after a previous cleaning and disinfection.

INSTRUCTION

Due to the design of instruments and the used materials, it is not possible to determine a limited number of reprocessing cycles. The lifetime of surgical instruments is therefore determined by the function / wear of the device. In case of damage the device must be reprocessed before sending back to the manufacturer for repair.

REPROCESSING INSTRUCTIONS

Preparation at the point of use: Remove gross soiling by submerging the instrument into cold water (<40°C) immediately after use.

Don't use a fixating detergent or hot water (>40°C) as this can cause the fixation of residuals which may influence the result of the reprocess- in process.

TRANSPORTATION

Safe storage and transportation in a closed container to the reprocessing area to avoid any damage and contamination to the environment.

PREPARATION FOR DECONTAMINATION

The devices must be reprocessed in an opened or disassembled state. Instruments must be placed on adequate supports or trays. The nature of the supports or trays must not have any negative influence on the result of the following cleaning and disinfection by rinsing or ultrasonic treatment.

MANUAL PRE CLEANING

Immerse the instrument into cold tap water for at least 5 minutes. Dismantle the instruments if possible and brush under cold tap water until all visible residues are removed. Inner lumen, threads and holes are flushed each with a water jet pistol for minimum 10 seconds in the pulsed mode. Immerse the instrument into an ultrasonic bath with an alkaline or enzymatic detergent (0,5%) and treat with ultrasound for 15 minutes at 40°C.

Remove the instruments from the bath and rinse again with cold tap water.

The cleaning bath must be changed at least once a day, or if required. Any pollution may influence the result of cleaning / disinfection and may favor corrosion.

MANUAL CLEANING

In case of manual cleaning, the cleaning process needs to be adapted to the pre-treatment. The used detergents must be compatible, in order to avoid any negative influence on the cleaning/disinfection result. The detergent must be suitable for the treatment of surgical instruments.

User Manual

The manufacturer's instructions regarding concentration and reaction time must be strictly obeyed. Use only soft brushes, no metal brushes. Channels and hollow parts must be rinsed thoroughly. If necessary, a high pressure hose must be used.

- Rinse the instruments with running clear water.
- Dry the instruments thoroughly.
- The cleaning bath must be changed at least once a day, or if required.

CHEMICAL DISINFECTION

The chemical disinfection follows the manual cleaning. A detergent, suitable for surgical instruments made of stainless steel must be used.

PACKAGING STORAGE

Storage of sterilized instruments in appropriate packaging in a dry, clean and dust free environment at modest temperatures of 5°C to 40°C, and at a constant humidity. The distance between shelf and floor should be at least 30cm. Storage duration time is to be determined by the user.

Reprocessing validation study information:

The following testing test devices, materials & machines have been used in this validation study; Detergent:

ADDITIONAL INSTRUCTIONS

If the described chemistry and machines are not available, it is the duty of the user to validate his process. It is the duty of the user to ensure that the reprocessing processes including resources, materials and personnel are capable to reach the required results. State of the art and often national law requiring these processes and included resources to be validated and maintained properly.

WARRANTY

The products are made of high grade medical stainless steel and are controlled prior to sale. In case of any error or inconvenience, please feel free to contact our service.

Coltene Dental Supplier cannot provide any guarantee weather the instruments are suitable for the respective intervention. This has to be determined by the user.

Coltene Dental Supplier does not provide any liability for any damages arising from pure chance. Coltene Dental Supplier does not provide any liability for any damages deriving from contravening against this manual. In case of using the instruments on patients with Coltene Dental Supplier does not provide any liability for the reprocessing of the instruments.

Yours very sincerely,

Management and Staff Coltene Dental Supplier
Coltene Dental Supplier Product Launches

Polypus and dressing forceps

Surgery

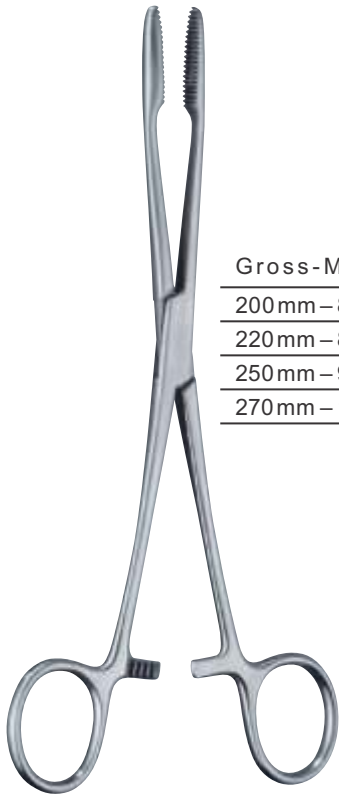

Gross-Maier

200mm – 8"	Coltene 15110-20	Coltene 15111-20
220mm – 8¾"	Coltene 15110-22	Coltene 15111-22
250mm – 9¾"	Coltene 15100-25	Coltene 15101-25
270mm – 10¾"	Coltene 15100-27	Coltene 15101-27

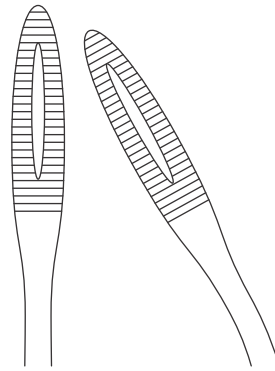
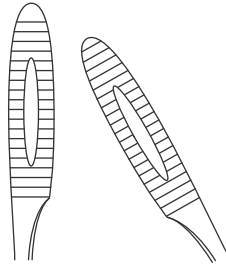

Maier

200mm – 8"	Coltene 15112-20	Coltene 15113-20
250mm – 9¾"	Coltene 15102-25	Coltene 15103-25

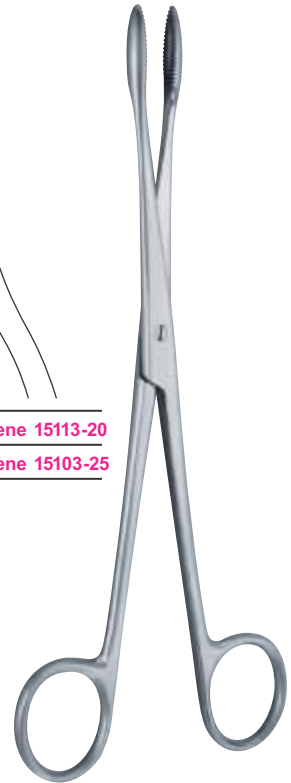

Ulrich

220mm – 8¾"	Coltene 15120-22	Coltene 15121-22
250mm – 9¾"	Coltene 15120-25	Coltene 15121-25
270mm – 10¾"	Coltene 15120-27	Coltene 15121-27
350mm – 14"	Coltene 15120-35	Coltene 15121-35

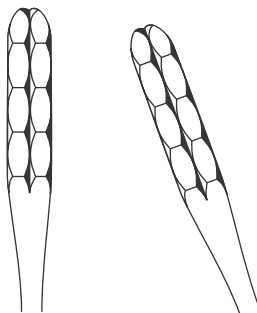

Sponge holding forceps

Surgery

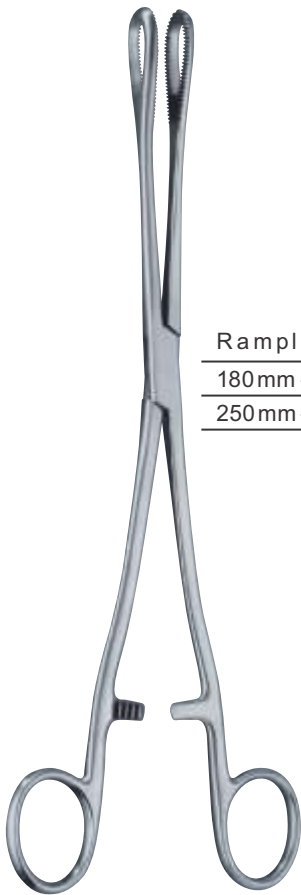

Rampley

180mm – 7"	Coltene 15130-18	
250mm – 9¾"	Coltene 15130-25	Coltene 15131-25

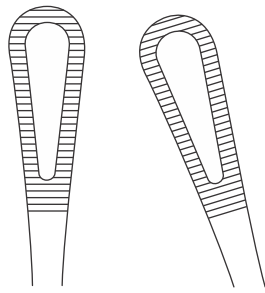

Collin

250mm – 9¾"	Coltene 15150-25
-------------	------------------

1:1

1:2

Sponge holding forceps

Surgery



Cheron
250mm – 9¾" **Coltene 15160-25**

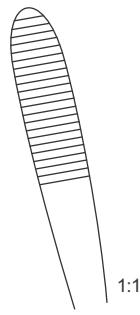

Bergmann-
Foerster
250mm – 9¾" **Coltene 15190-25** **Coltene 15191-25**

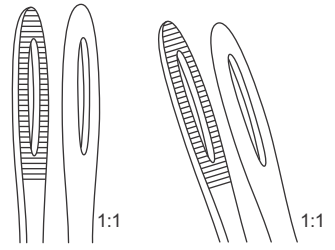

Sponge holding forceps

Surgery

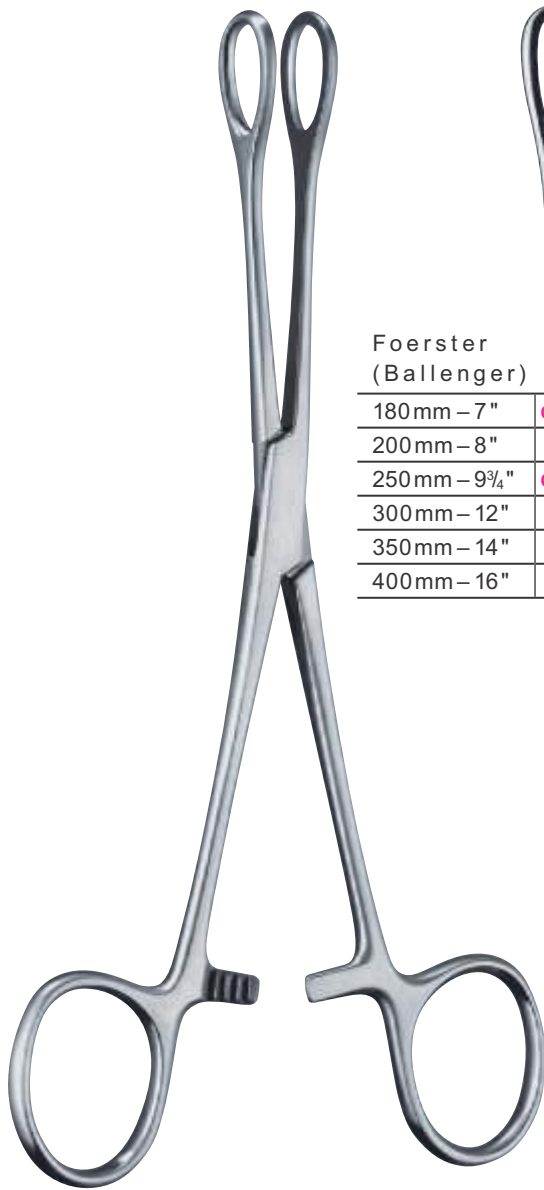

Foerster
(Ballenger)

180mm – 7"	Coltene 15180-18	Coltene 15182-18	Coltene 15183-18	Coltene 15185-18
200mm – 8"		Coltene 15182-20		Coltene 15185-20
250mm – 9¾"	Coltene 15180-25	Coltene 15182-25	Coltene 15183-25	Coltene 15185-25
300mm – 12"		Coltene 15182-30		
350mm – 14"		Coltene 15182-35		
400mm – 16"		Coltene 15182-40		

Sponge holding forceps

Surgery

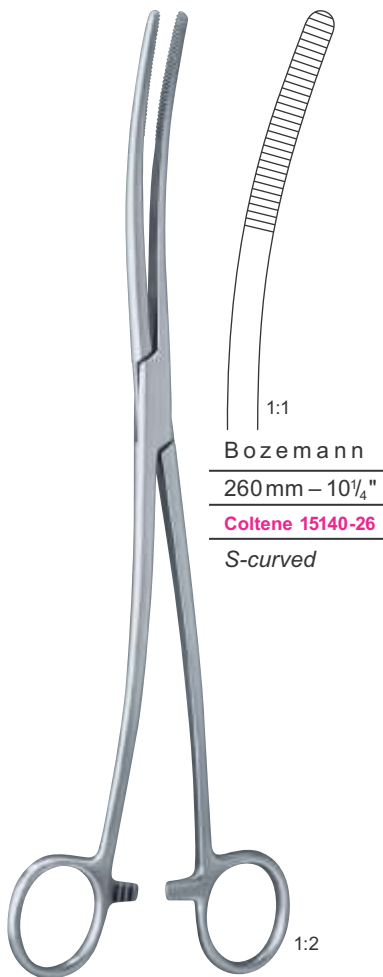

Polypus and dressing - sponge holding forceps

Surgery



Pelkman
250 mm - 9 3/4" **Coltene 15186-25**



1:2



Martin

170 mm - 6 3/4"	Coltene 15200-17	Coltene 15201-17
255 mm - 10"	Coltene 15200-25	Coltene 15201-25

Polypus and dressing - sponge holding forceps

Surgery

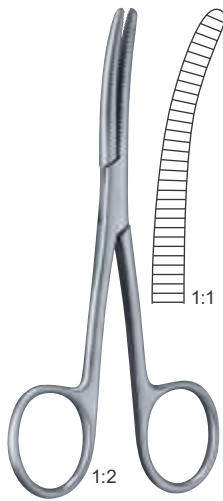

Bryant 1:2
130mm - 5" **Coltene 15305-13**

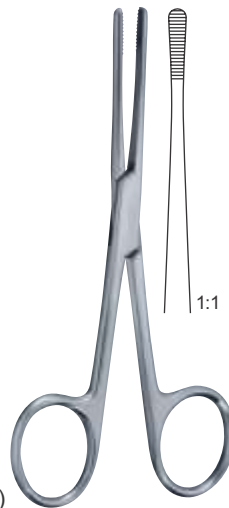

Lister (Sinus) 1:1
130mm - 5" **Coltene 15300-13**
160mm - 6¹/₄" **Coltene 15300-16**
180mm - 7" **Coltene 15300-18**

Sinus forceps

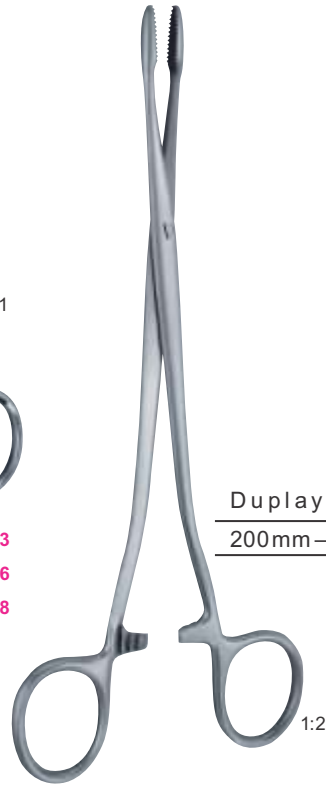

Duplay 1:2
200mm - 8" **Coltene 15220-20** **Coltene 15221-20**



Manufacturing Process

Manufacturing Capabilities

All of our production departments are well equipped with the latest, machinery which is imported from Germany and England, and well staffed with the expert technicians.

Raw Material Department

Coltene Dental Supplier always purchases best quality stainless steel raw material from steel manufacturers or import directly from Japan, France and Germany when need to do so.

Two kinds of series i.e. (304, 410 and 420) of stainless steel are used for production of Instruments. At Coltene Dental Supplier, we believe that quality can only be achieved through quality raw material. As such, the best quality Raw-materials (Stainless Steel Strips, Round Bars, Stainless Steel Coils and Stainless Steel Tubes) are purchased and are subjected to composition and hardness testing through our in-house laboratory in order to ensure that only the best materials are passed from production departments.

Forging Department

Coltene Dental Supplier has its own forging section where forgings are made through Drop Hammer process by seasoned operators using dyes made of the best quality imported D-2 Steel.

Forging is done by keeping in mind that the geometry of this process is a starting point and does not on any way limit your design freedom.

Milling Department

Milling is used in the instruments, defined as the process of cutting, shaping and finishing of an instrument. It is the process that includes turning, welding and fringing. At the Coltene Dental Supplier we use the best milling technology which involve cutting away pieces of metal to create dovetails, threads, bevels, slots and ridges.

Grinding (Filing & Setting)

In order to give a final shape to the instrument, our highly skilled craftsmen use filling and grinding processes which removes the material from the instrument by abrasion. Then the instrument is keenly observed and set to perform perfect.

Hardness Test (Heat Treatment)

For surgical instruments, the term harness refers to the resistance to bending, scratching, abrasion or cutting. We have in-house Heat Treatment Department equipped with top quality Vacuum Furnace where qualified staff and engineers are engaged in treating the instruments in order to add strength to the steel and perfect the metallurgical composition for further processes.

Polishing Department

The Polishing Department is manned by seasoned workmen using imported chemicals and best quality grinding wheels to ensure the best quality finish. In this department, the instruments are given final finish which includes mirror, satin or matt finishes. The finish is per customers requirements.

Manufacturing Process

Tungsten Carbide Department

Coltene Dental Supplier tungsten carbide department is installed with the best quality imported machinery being manned by the exceptionally well trained experts using the German Technology. We use German tungsten carbide tips for our instruments.

Coating Department

Our coating department is capable of providing gold plated instruments as well as powder coated instruments depending upon the requirements of the instruments or the customers. Best quality coating related raw materials are used so that no compromise can be made on quality. Furthermore, each coating is inspected for quality before any instrument is passed on to the next department.

Passivation Department

We use high quality imported chemicals in our Passivation Department. Every instruments is boil test and passivate for 24 hours before packing. If need arises, the instruments are re-passivated so as to eliminate any chances of rusting or corrosion during the life of the instrument. Our instruments are rust-free for life though we give guarantee for five years.

Sandblasting Department

For sandblasting our instruments, we use the machines as well as the best quality sandblasting material, which are operated by skilled & well trained operators.

Stamping/Etching

We use permanent and long life high quality laser etching which produces a wide variety of text and graphic images including our customer's logo with very detailed and fine image quality.

Quality Control

Our quality control department is involved at all of the processes of manufacturing but before the instrument goes to the packing department, its quality and function is thoroughly checked by our qualified engineers.

Labeling and Packing

Each instrument is initially packed in a poly bag to prevent scratches and then packed in the middle box. Middle boxes are then packed in the carton. The middle boxes are labeled which includes the article number, types and sizes of instruments. We can also arrange packaging and labeling **according to the customers** demand.

Warehouse

After the instruments are packed and labeled, cartons are then move to our in house warehouse where the complete record of shipments are maintained by our qualified warehouse management.

COLTENE
DENTAL SUPPLIER

*Manufacturer and Exporter all kinds of
Surgical Instruments, Dental Instruments*



SURGICAL INSTRUMENTS

